

MARTHA

ALINA

Н 60 ДШ / Н 80 ДШ

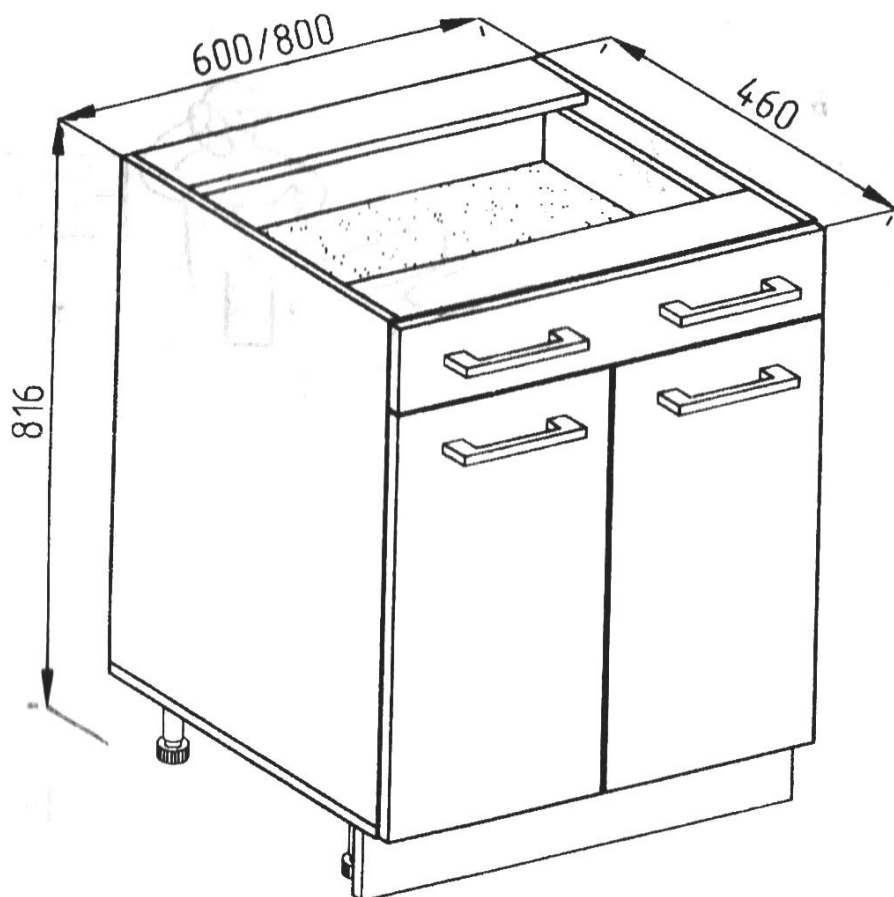





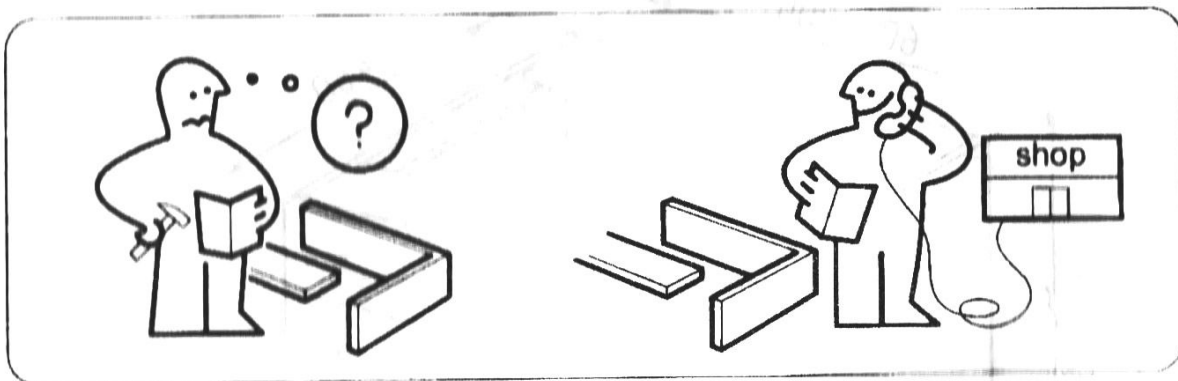
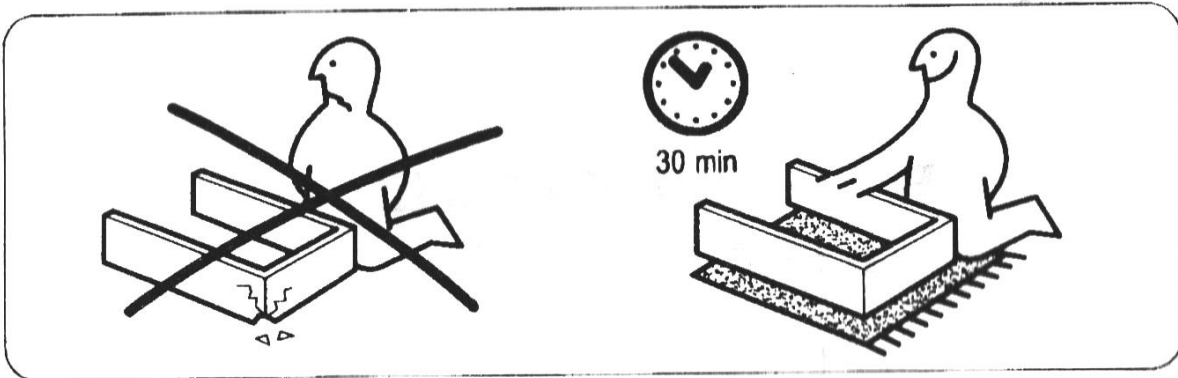
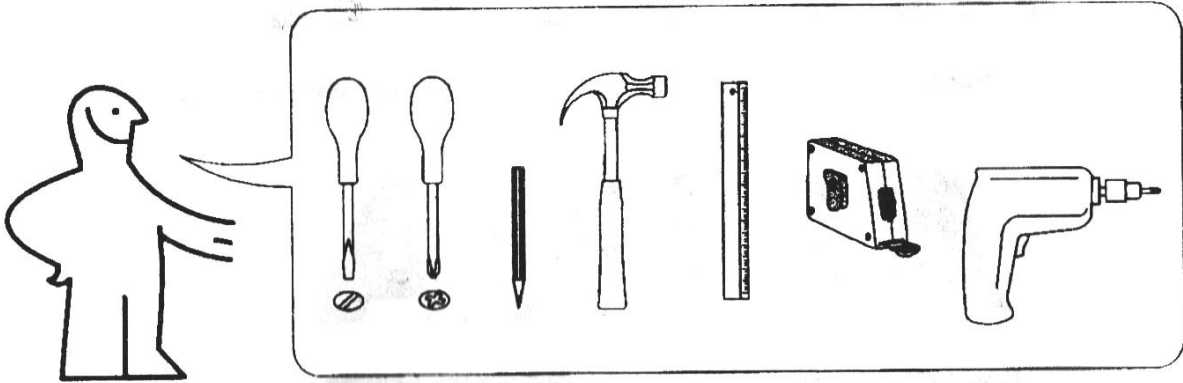













D 60 DDr / D 80 DDr



Martha
Alina



Martha
Alina

 A1 8*30mm x12	 B ϕ 12mm x10	 B1 6,3*50mm x10
 D x2	 D1 16mm x2	 C1 5*30mm x2
 E1 3*13mm x10	 E8 4*16mm x28	 E11 4*30mm x8
 E13 4*40mm x8	 F1 6,3*13mm x8	 M1 L-400 x1
 I8 x4	 L1 x4	 J1 5*16mm x4
 P1 x1	 Q1 1,4*25mm 0.02kg	 K2 x4
 K3 x2	 U3 x6	

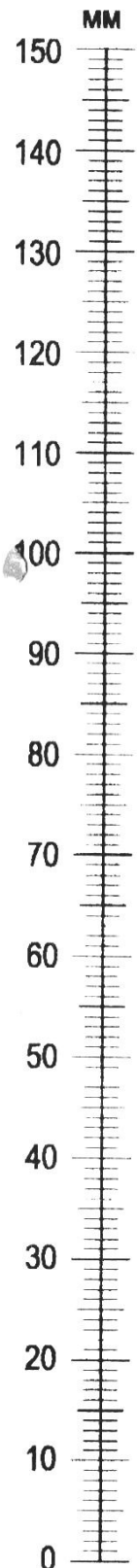





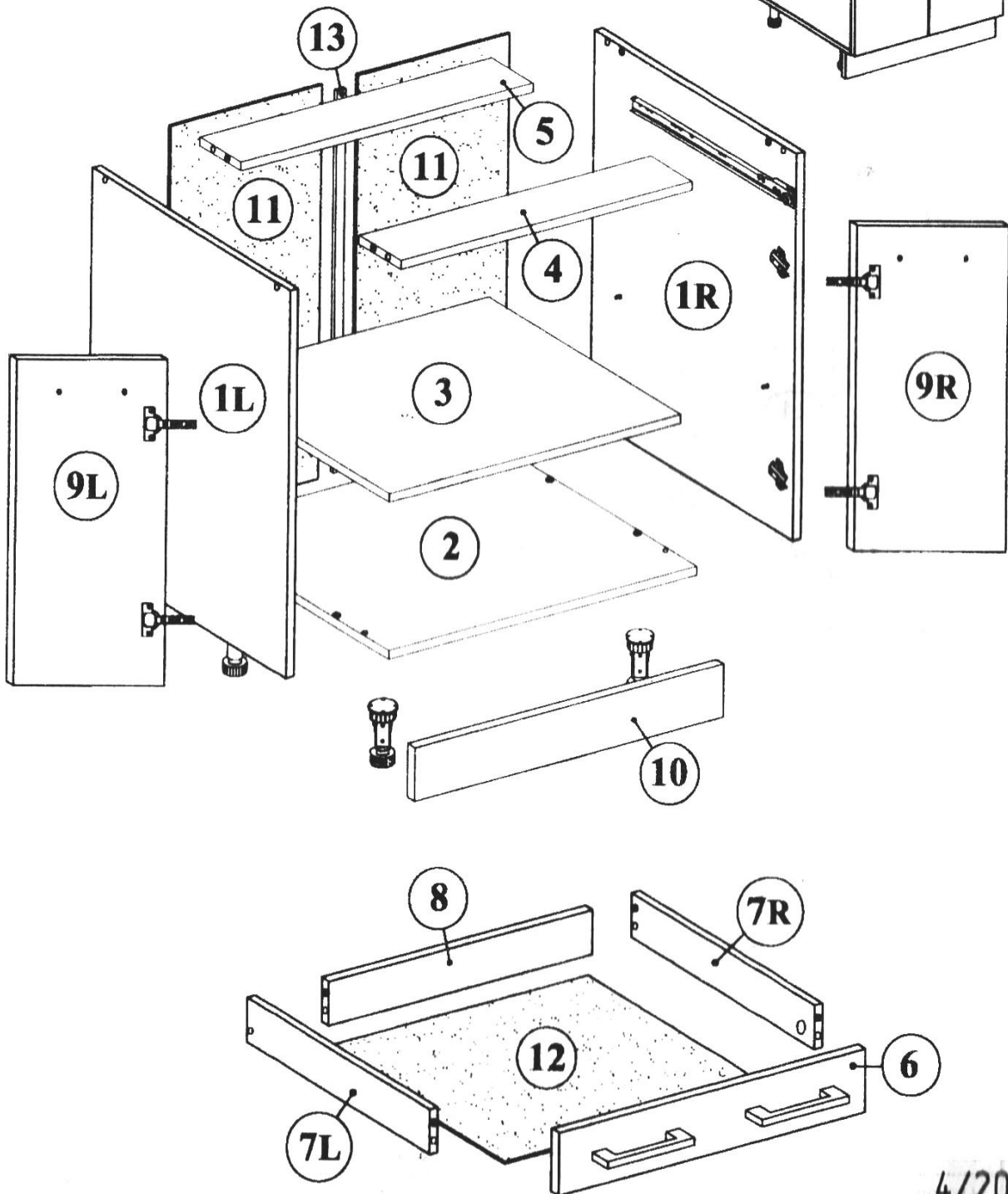
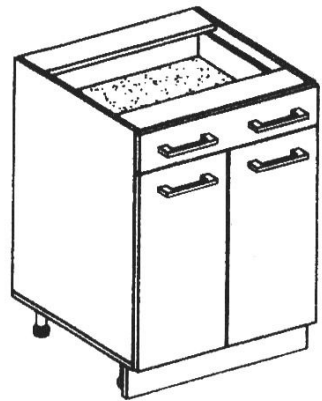

№	a*b		№=...	№	a*b		№=...
	№одш (D 60 DDr)	№одш (D 80 DDr)			№одш (D 60 DDr)	№одш (D 80 DDr)	
1 L	700x440	700x440	1	7 R	400x80	400x80	1
1 R	700x440	700x440	1	8	510x80	710x80	1
2	600x440	800x440	1	9 L	296x590	396x590	1
3	567x420	767x420	1	9 R	296x590	396x590	1
4	567x90	767x90	1	10	599x96	799x96	1
5	567x90	767x90	1	11	713x296	713x396	2
6	596x118	796x118	1	12	404x540	404x740	1
7 L	400x80	400x80	1	13	L-682	L-682	1

Martha
Alina



Martha
Alina

1

 A1 8*30mm x4	 J1 5*16mm x4	 L1 x4
 F1 6,3*13mm x8	 E1 3*13mm x6	 M1 L-400 x1

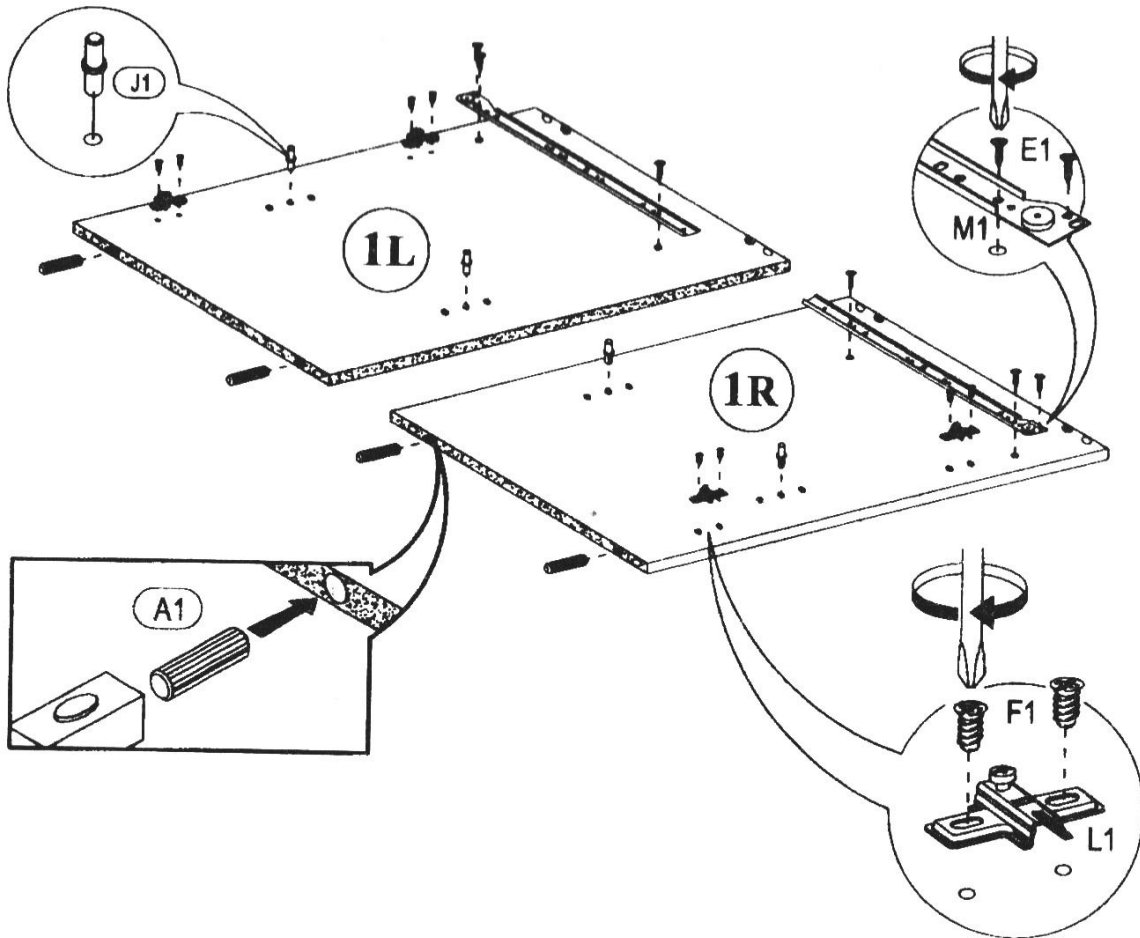

Martha
Alina

